

1905 CLIC Twin Vertical Minisize T5



IP 20

Order Code Highlights:

(See attached order code matrix for all options. A complete order code consists of 20 digits.)

MODEL NUMBER (AAAA)
1905

MOUNTING (BB)
Aircraft Cable Suspension (03)

LAMP TYPE (CC)
T5 (02)

EXTRUSION COLOR (G)
Clear Anodized (1)
White (2)
Custom (3)

SHIELDING (H)
Linear Spread Acrylic Lens (1)
Lens Up/Metal Louver Down (6)

POWERFEED (J)
Cord (2)

BALLAST/DRIVER (K)
Non-dimming (1)
Dimming 0-10 Volt Analog (8)

EMERGENCY (L)
Non-emergency (1)

OTHER (M)
Seamless Lamp (down light only) (a)

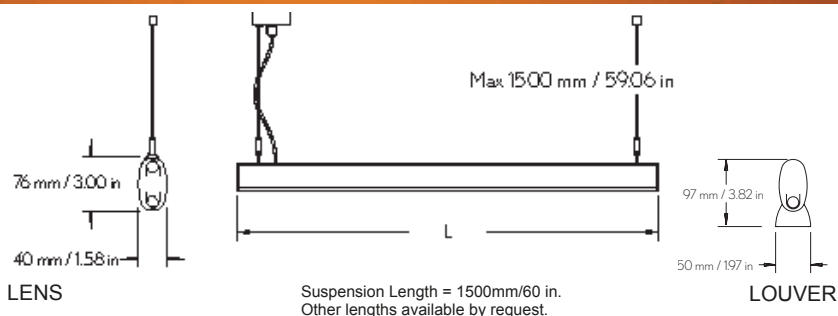

Order Code AAAA BB CC DD EE/EE F G H I J K L M	Length (L)	Lamp
1905 03 02 02 06 or 09 x x x x x x 1 x	605mm/23.82 in.	T5/T5HO 14 or 24 Watts
1905 03 02 02 08 or 13 x x x x x x 1 x	905mm/35.63 in.	T5/T5HO 21 or 39 Watts
1905 03 02 02 10 or 16 x x x x x x 1 x	1205mm/47.44 in.	T5/T5HO 28 or 54 Watts
1905 03 02 02 13 x x x x x x 1 x	1505mm/59.25 in.	T5 35 Watts
1905 03 02 04 08 or 13 x x x x x x 1 x	1805mm/71.06 in.	T5/T5HO 2 x 21 or 39 Watts
1905 03 02 04 10 or 16 x x x x x x 1 x	2405mm/94.69 in.	T5/T5HO 2 x 28 or 54 Watts
1905 03 02 04 13 x x x x x x 1 x	3005mm/118.31 in.	T5 2 x 35 Watts

Other lengths available by request.
Length includes end caps.



www.smedmarksinc.com

EFFICIENT VERSATILE ADAPTABLE CUSTOMIZABLE

1905 CLIC Twin Vertical Minisize T5



POLAR GRAPH

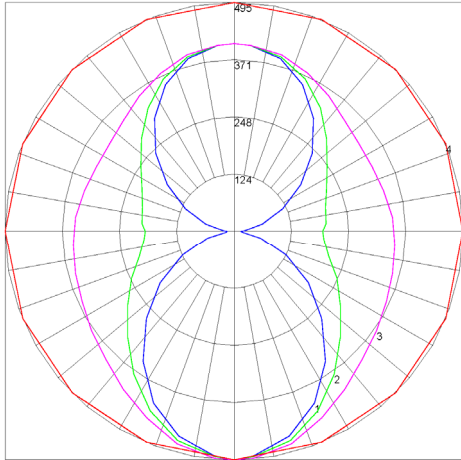

Maximum Candela = 495 Located At Horizontal Angle = 0, Vertical Angle = 0
 # 1 - Vertical Plane Through Horizontal Angles (0 - 180) (Through Max. Cd) : BLUE
 # 2 - Vertical Plane Through Horizontal Angles (45 - 225) : GREEN
 # 3 - Vertical Plane Through Horizontal Angles (90 - 270) : MAGENTA
 # 4 - Horizontal Cone Through Vertical Angle (0) (Through Max. Cd) : RED

POLAR GRAPH

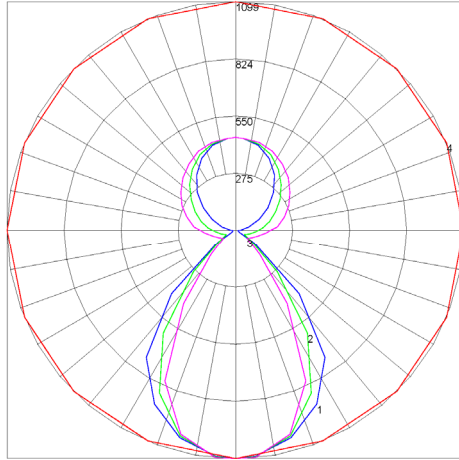

Maximum Candela = 1099 Located At Horizontal Angle = 0, Vertical Angle = 0
 # 1 - Vertical Plane Through Horizontal Angles (0 - 180) (Through Max. Cd) : BLUE
 # 2 - Vertical Plane Through Horizontal Angles (45 - 225) : GREEN
 # 3 - Vertical Plane Through Horizontal Angles (90 - 270) : MAGENTA
 # 4 - Horizontal Cone Through Vertical Angle (0) (Through Max. Cd) : RED

POLAR GRAPH

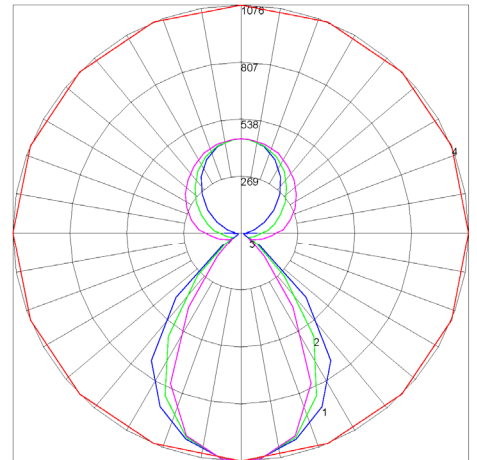

Maximum Candela = 1076 Located At Horizontal Angle = 0, Vertical Angle = 0
 # 1 - Vertical Plane Through Horizontal Angles (0 - 180) (Through Max. Cd) : BLUE
 # 2 - Vertical Plane Through Horizontal Angles (45 - 225) : GREEN
 # 3 - Vertical Plane Through Horizontal Angles (90 - 270) : MAGENTA
 # 4 - Horizontal Cone Through Vertical Angle (0) (Through Max. Cd) : RED

Acrylic Lens 2x28 Watt T5

Metal Louver Covered Sides

Metal Louver Uncovered Sides

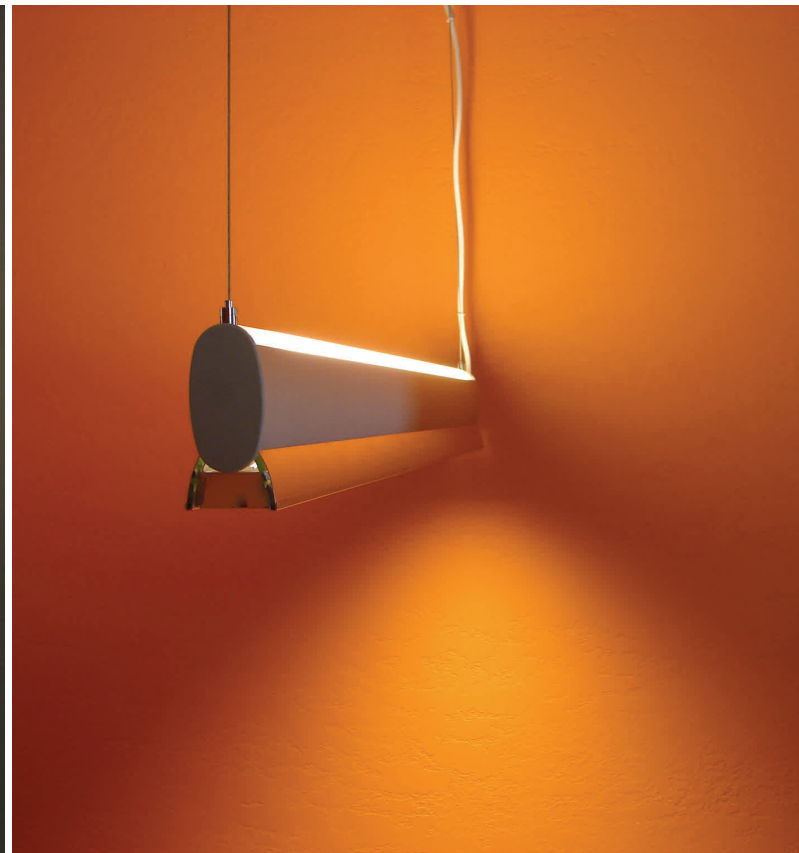
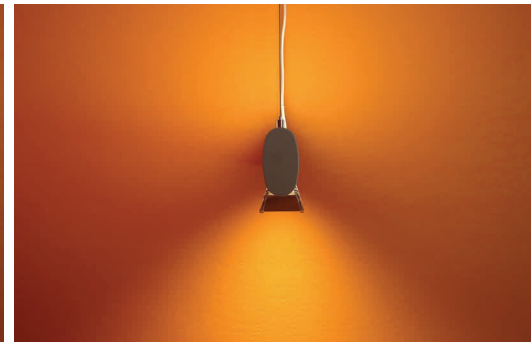
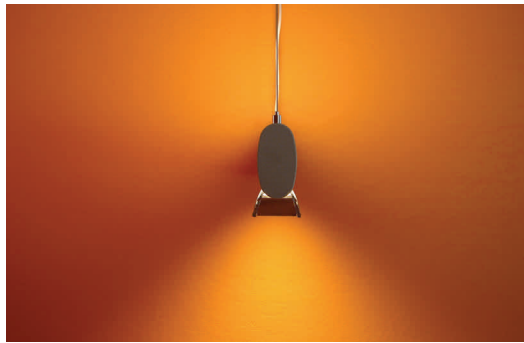

EFFICIENT VERSATILE ADAPTABLE CUSTOMIZABLE

CLIC TWIN VERTICAL MINISIZE T5

PRODUCT CODE
1905

ORDER/SPECIFICATION CODE MATRIX

Complete Code = AAAABBCCDDEEFGHIJKLM (20 Digits)

AAAA	BB	CC	DD	EE	F	G	H	I	J	K	L	M
PRODUCT CODE	MOUNTING	LAMP TYPE	LAMP QTY	LAMP WATTS	LAMP COLOR	EXTRUSION COLOR	SHIELDING	ENDCAP	POWER FEED	BALLAST TYPE	EMERGENCY	OTHER
1905	01=Custom 03=A/C Cable	02=T5	02=2 04=4 06=6 etc.	01=6 02=8 04=11 05=13 06=14 08=21 09=24 10=28 11=35 13=39 16=54	2=830 3=835 4=841 5=850 6=865 7=Red 8=Green 9=Blue	1=Clear Anodized 2=White 3=Custom	1=Acrylic Lens Linear Spread 3=Metal Louver	1=Custom 4=White Opaque 6=Gray Plastic 7=Gray Aluminum 8= White Aluminum	1=Plug 2=Cord	1=Non-dimming Univ Volts 2=Dimming ECO 120V 3=Dimming Hi-Lume 120V 4=Dimming ECO 277V 5=Dimming Hi-Lume 277V 6=Dimming Stepped Univ 7=Dimming DALI Univ 8=Dimming 0-10V Univ 9=Dimming Powerline Univ	1=Non-Emergency	0=Standard 1=Ecosystem Type 1 2=Ecosystem Type 2 3=Ecosystem Type 3 a=Seamless Lamp (down light only)
	See Separate Page For Illustrations								See Separate Page For Illustrations			See Separate Page For Illustrations

1 9 0 5 0 2 1

A A A A B B C C D D E E F G H I J K L M



Smedmarks Inc.
190 Muttart Rd.
Neenah, WI 54956-9710 USA
(920) 751-0323
www.smedmarksinc.com